

Name: \_\_\_\_\_  
Mrs. Blasofsel  
English III / IV  
[       ] \_\_\_\_\_ 20\_\_

### Christmas Vacation Brain Teasers Extra Credit

I love the holidays. Each year childhood memories flood my mind: stockings overflowing with candy (and oranges), bright lights twinkling on our “Charlie Brown” tree, family sharing smiles and laughter, and excitement of opening one present early. Once I had children of my own, I added to those memories: wrapping presents, making “Santa” noises, *again* family sharing smiles and laughter, and *again* selecting one present for them to open early. Now that my children have families of their own and live away from home, as my classroom students, you have become my “children,” so it is with great sincerity that I wish for you happiness during our holidays as you build your own holiday memories. To keep my family tradition alive, I am giving you a present to open early...an opportunity for extra credit! Attached you will find several brain teasers to keep your mind relaxed yet active during our school break. Some brain teasers are more challenging than others, but I’m confident you’ll find at least one that you’ll enjoy. You may choose to skip this entire opportunity or you may choose to complete one or a combination including all 15 brain teasers. In order to earn the extra credit, you must have the correct answers for the entire brain teaser (all pages and/or puzzles). Although you may certainly complete the brain teasers on your own, they are much more enjoyable when you share them with your family... as long as you are a significant part of the deciphering conversation because after all, making memories with family is important.

#### Table of Contents:

1. [       ] Christmas Songs	1 page	2 pts
2. [       ] Name that Tune	1 page	2 pts
3. [       ] Christmas Movie Quote	1 page	3 pts
4. [       ] Christmas Classics Trivia	1 page	3 pts
5. [       ] Link Winks	2 pages/ 12 puzzles	10 pts
6. [       ] Deducibles	2 pages/ 8 puzzles	10 pts
7. [       ] Quotagrams	1 page/ 3 puzzles	5 pts
8. [       ] Quotefalls	1 page/ 3 puzzles	5 pts
9. [       ] Vacation Fun	1 page/ 1 puzzle	5 pts
10. [       ] Chasing Tourist	1 page/ 1 puzzle	5 pts
11. [       ] Petal Pair	2 pages / 8 puzzles	10 pts
12. [       ] Word Wheel	2 pages / 4 puzzles	10 pts
13. [       ] Word Winks	2 pages / 18 puzzles	10 pts
14. [       ] Chain Reaction	2 pages / 2 puzzles	10 pts
15. [       ] Honeycomb Loops	2 pages / 4 puzzles	10 pts

Total Possible Extra Credit Points: [       ] /100 pts

The only date you may submit completed brain teasers for extra credit is on Tuesday, January 2 at the beginning of class. Check them off on this form and attach this form to your completed brain teasers. Good luck and Merry Christmas! I hope you enjoy your present :->

Sincerely,

Mrs. 



- 1.
- 2.
- 3.
- 4.
- 5.
- 6.
- 7.
- 8.
- 9.
- 10.
- 11.
- 12.
- 13.
- 14.
- 15.
- 16.
- 17.
- 18.
- 19.
- 20.
- 21.
- 22.
- 23.
- 24.
- 25.
- 26.
- 27.
- 28.
- 29.
- 30.
- 31.
- 32.
- 33.
- 34.
- 35.
- 36.
- 37.
- 38.
- 39.
- 40.

# Can you Name That Tune?

Each line below is a clue to a well-known yuletide song. You'll have to decode some lofty language to come up with the carols, so if you're ready...get humming! (Thanks to Reader's Digest 2006)



1. Listen to the celestial messengers produce harmonious sounds.
2. Embellish the interior passageways.
3. Twelve o'clock on a clement night witnessed its arrival.
4. The Christmas preceding all others.
5. Small municipality in Judea south of Jerusalem.
6. Omnipotent Supreme Being who elicits respite in distinguished males.
7. Nocturnal time span of unbroken quietness.
8. Obese personification fabricated of compressed mounds of minute crystals.
9. Tintinnabulation of vacillating pendulums in inverted, metallic, resonant cups.
10. In awe of the eventide characterized by religiosity.

## Christmas Movie Quotes

Identify these popular Christmas movies AND fill in the blanks to their popular quotes using the words provided.

### Word Bank

Chocolate	Mushrooms	Emphasize	Skipping	Snowman	Vermont	Planes
Shepherd	Workshop	Santa	Cheese	Christmas	Elves	Reality
Delusion	Girl	Holiday	Spirits	Bounce	Teacher	Corn
Store	Faith	Family	Snow	Bell	Whole	Joyful

1. Aunt Clara had for years labored under the \_\_\_\_\_ that I was not only perpetually 4 years old, but also a \_\_\_\_\_. Movie: \_\_\_\_\_
2. Well, this is one Christmas \_\_\_\_\_ who's going to keep his trusty blanket with him. (Movie: \_\_\_\_\_)
3. Look, Daddy. \_\_\_\_\_ says every time a \_\_\_\_\_ rings, an angel gets his wings. (Movie: \_\_\_\_\_)
4. It's just like Santa's \_\_\_\_\_! Except it smells like \_\_\_\_\_ and everyone looks like they wanna hurt me. (Movie: \_\_\_\_\_)
5. Mortal, we \_\_\_\_\_ of Christmas do not live only one day of the year. We live the \_\_\_\_\_ 365. (Movie: \_\_\_\_\_)
6. What's the matter? Haven't you ever seen a talking \_\_\_\_\_ before? (Movie: \_\_\_\_\_)
7. This is extremely important. Will you please tell \_\_\_\_\_ that instead of presents this year, I just want my \_\_\_\_\_ back. (Movie: \_\_\_\_\_)
8. We \_\_\_\_\_ like to stick to the four main food groups: candy, candy canes, candy \_\_\_\_\_, and syrup. (Movie: \_\_\_\_\_)
9. I know nobody likes me. Why do we have to have a \_\_\_\_\_ season to \_\_\_\_\_ it? (Movie: \_\_\_\_\_)
10. Blast this Christmas music. It's \_\_\_\_\_ and triumphant. (Movie: \_\_\_\_\_)
11. Can we take a direct flight back to \_\_\_\_\_, or do we have to change \_\_\_\_\_ in Denver? (Movie: \_\_\_\_\_)
12. Not too hot. Extra \_\_\_\_\_. Shaken, not stirred. (Movie: \_\_\_\_\_)
13. Maybe \_\_\_\_\_ doesn't come from a \_\_\_\_\_. Maybe Christmas...means a little bit more. (Movie: \_\_\_\_\_)
14. You smell like beef and \_\_\_\_\_. You don't smell like Santa. (Movie: \_\_\_\_\_)
15. You're \_\_\_\_\_ Christmas! Isn't that against the law? (Movie: \_\_\_\_\_)
16. \_\_\_\_\_ is believing when common sense tells you not to. (Movie: \_\_\_\_\_)
17. Oh \_\_\_\_\_ should be beautiful this time of year, with all that \_\_\_\_\_. (Movie: \_\_\_\_\_)
18. Didn't I ever tell you about Bumbles? Bumbles \_\_\_\_\_. (Movie: \_\_\_\_\_)

# CHRISTMAS CLASSICS TRIVIA

1. Including Rudolph, how many reindeer pull Santa's sleigh? \_\_\_\_\_
2. What was the name of the magician in *Frosty the Snowman*? \_\_\_\_\_
3. How many "drummers drumming" are there in the song "The 12 Days of Christmas?" \_\_\_\_\_
4. What does Alvin the Chipmunk want for Christmas in "The Chipmunk Song?" \_\_\_\_\_
5. How many ghosts visit Scrooge in *A Christmas Carol*? \_\_\_\_\_
6. What does Ralphie want for Christmas in the movie *A Christmas Story*? \_\_\_\_\_
7. Where does the Grinch live? \_\_\_\_\_
8. Where did the McCallister family go on vacation when they left Kevin alone in *Home Alone*? \_\_\_\_\_  
\_\_\_\_\_
9. What city was the baby Jesus born in? \_\_\_\_\_
10. What three gifts did the wise men bring the baby Jesus? \_\_\_\_\_
11. How did the shepherds find baby Jesus? \_\_\_\_\_
12. Which state produces the most Christmas trees? \_\_\_\_\_
13. What is the name of the elf who wants to be a dentist in *Rudolph the Red nosed Reindeer*? \_\_\_\_\_  
\_\_\_\_\_
14. The movie *Miracle on 34<sup>th</sup> Street* takes place in what city? \_\_\_\_\_
15. Who kisses Lucy in *A Charlie Brown Christmas*? \_\_\_\_\_
16. In the movie *It's A Wonderful Life*, how did George Bailey become deaf in one ear? \_\_\_\_\_  
\_\_\_\_\_
17. What Christmas carol includes "figgy pudding?" \_\_\_\_\_
18. What fruit does Santa's nose look like? \_\_\_\_\_
19. What is the name of the main character in *Elf*? \_\_\_\_\_
20. Who kept time with the Little Drummer Boy when he played his drum for baby Jesus? \_\_\_\_\_  
\_\_\_\_\_

# Link Winks

Each puzzle contains three clues. Your challenge is to solve the clues with answers that rhyme. The rhyming answers can be definitions, associations, or interpretations of the clues. Some answers may be proper nouns. All answers within one puzzle will have the same number of syllables. For example, *nose*, *rose* and *hose* could be a correct solution as could *jacket*, *racquet*, and *packet*. However, *scare*, *stare* and *beware* could not be a correct solution.

\_\_\_\_\_ To journey  
\_\_\_\_\_ A judge's mallet  
\_\_\_\_\_ A type of road material

\_\_\_\_\_ Fearless and daring  
\_\_\_\_\_ Lacking warmth  
\_\_\_\_\_ An Olympic medal

\_\_\_\_\_ A present  
\_\_\_\_\_ A split in a relationship  
\_\_\_\_\_ An elevator in England

\_\_\_\_\_ Flower pollinators  
\_\_\_\_\_ Leg joints  
\_\_\_\_\_ Pod partners

\_\_\_\_\_ The season of cold temperatures  
\_\_\_\_\_ One who runs at full speed  
\_\_\_\_\_ A sharp, slender piece of wood

\_\_\_\_\_ In good physical shape  
\_\_\_\_\_ In good financial standing  
\_\_\_\_\_ In a secretive manner

\_\_\_\_\_ **Laughter**  
\_\_\_\_\_ **A bed on a ship or train**  
\_\_\_\_\_ **The distance around your middle**

\_\_\_\_\_ **Your eyes do this**  
\_\_\_\_\_ **You read this**  
\_\_\_\_\_ **You move this on a chess board**

\_\_\_\_\_ **Slumber**  
\_\_\_\_\_ **An animal that is sheared**  
\_\_\_\_\_ **A sharp incline**

\_\_\_\_\_ **To put on salt and pepper**  
\_\_\_\_\_ **The power of intelligent thought**  
\_\_\_\_\_ **A traitor's crime**

\_\_\_\_\_ **A comic quality causing amusement**  
\_\_\_\_\_ **Unconfirmed gossip**  
\_\_\_\_\_ **An abnormal growth of cells**

\_\_\_\_\_ **A pirate's chest of gold**  
\_\_\_\_\_ **To determine the length of something**  
\_\_\_\_\_ **A feeling of enjoyment**

## Deducibles

The solution does not use any letter more than once, so any letter that appears more than once throughout the entire puzzle should be crossed out. Use the clues for each horizontal row to eliminate and sequence the letters in that row. Reveal the solution by writing the correct letter or letters from each horizontal row in the correct circles above. You may need to solve some clues before you can solve others.

○ ○ ○ ○ ○ ○ ○

<b>J</b>	<b>K</b>	<b>Q</b>	<b>P</b>	<b>O</b>	<b>Z</b>	<b>X</b>	<i>one correct, wrong place</i>
<b>C</b>	<b>P</b>	<b>G</b>	<b>Q</b>	<b>V</b>	<b>E</b>	<b>T</b>	<i>two correct, right place</i>
<b>B</b>	<b>V</b>	<b>A</b>	<b>V</b>	<b>J</b>	<b>P</b>	<b>X</b>	<i>two correct, right place</i>
<b>D</b>	<b>X</b>	<b>H</b>	<b>N</b>	<b>Z</b>	<b>W</b>	<b>R</b>	<i>one correct, right place</i>
<b>F</b>	<b>L</b>	<b>M</b>	<b>P</b>	<b>V</b>	<b>I</b>	<b>Y</b>	<i>one correct, right place</i>

○ ○ ○ ○ ○ ○ ○

<b>N</b>	<b>C</b>	<b>O</b>	<b>P</b>	<b>V</b>	<b>R</b>	<b>D</b>	<i>one correct, wrong place</i>
<b>Z</b>	<b>W</b>	<b>I</b>	<b>S</b>	<b>M</b>	<b>H</b>	<b>Y</b>	<i>two correct, right place</i>
<b>T</b>	<b>D</b>	<b>H</b>	<b>F</b>	<b>A</b>	<b>B</b>	<b>R</b>	<i>one correct, right place</i>
<b>V</b>	<b>Y</b>	<b>A</b>	<b>B</b>	<b>K</b>	<b>Z</b>	<b>S</b>	<i>one correct, right place</i>
<b>O</b>	<b>L</b>	<b>M</b>	<b>F</b>	<b>C</b>	<b>G</b>	<b>E</b>	<i>two correct, one right place, right order</i>

○ ○ ○ ○ ○ ○ ○

<b>R</b>	<b>E</b>	<b>C</b>	<b>A</b>	<b>H</b>	<b>N</b>	<b>D</b>	<i>two correct, wrong place, wrong order</i>
<b>S</b>	<b>L</b>	<b>T</b>	<b>W</b>	<b>F</b>	<b>K</b>	<b>O</b>	<i>two correct, right place</i>
<b>H</b>	<b>Y</b>	<b>U</b>	<b>G</b>	<b>F</b>	<b>Y</b>	<b>W</b>	<i>one correct, right place</i>
<b>J</b>	<b>G</b>	<b>X</b>	<b>M</b>	<b>T</b>	<b>O</b>	<b>K</b>	<i>one correct, right place</i>
<b>C</b>	<b>X</b>	<b>J</b>	<b>A</b>	<b>B</b>	<b>D</b>	<b>N</b>	<i>one correct, right place</i>

○ ○ ○ ○ ○ ○ ○ ○

<b>B</b>	<b>P</b>	<b>H</b>	<b>K</b>	<b>N</b>	<b>J</b>	<b>Q</b>	<b>C</b>	<i>one correct, wrong place</i>
<b>A</b>	<b>S</b>	<b>V</b>	<b>D</b>	<b>X</b>	<b>W</b>	<b>U</b>	<b>G</b>	<i>one correct, wrong place</i>
<b>G</b>	<b>E</b>	<b>X</b>	<b>P</b>	<b>F</b>	<b>M</b>	<b>W</b>	<b>Y</b>	<i>two correct, right place</i>
<b>C</b>	<b>N</b>	<b>K</b>	<b>S</b>	<b>T</b>	<b>B</b>	<b>L</b>	<b>Q</b>	<i>two correct, right place</i>
<b>D</b>	<b>U</b>	<b>M</b>	<b>R</b>	<b>J</b>	<b>I</b>	<b>O</b>	<b>V</b>	<i>two correct, right place</i>



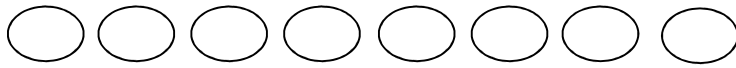

W H A Q T Z K G  
 K Y W Z Q X F S  
 B C J L M P V X  
 H E N Z V X P J  
 L O C U J R G C  
 G Q R W I V J K

*two correct, right place*  
*two correct, one right place, wrong order*  
*one correct, right place*  
*one correct, right place*  
*one correct, right place*  
*one correct, wrong place*



B Y H L W I Z J  
 C G Y X P Q U R  
 S M M A K Z W Q  
 T P N G P L O C  
 D E U T V J M S

*three correct, right place*  
*one correct, right place*  
*one correct, right place*  
*one correct, right place*  
*two correct, right place*

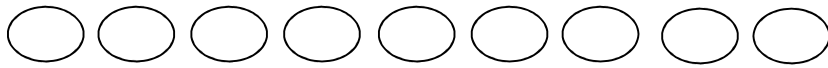

W V U L J T Z K H  
 C W G E Q B K R X  
 X K M Z A S P J N  
 P Q V V Q B I O L  
 H D X R Z G H S W

*two correct, right place*  
*two correct, wrong place*  
*two correct, right place*  
*two correct, right place*  
*one correct, right place*

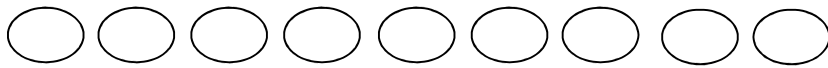

F L Y I O N Y K N  
 B R N M S C W G O  
 H V U D T Z S J W  
 P N L L S Y A Q E

*three correct, right place*  
*two correct, right place*  
*two correct, right place*  
*two correct, right place*

## Quotagrams

Fill in the answers to the clues. Then transfer the letters to the correspondingly numbered squares in the diagrams. The completed diagrams will contain quotations. Each letter from a quote will be used only once.

1. Saguaro (e.g.)

3 12 35 21 17 39

4. Flower vendor

1 28 32 16 5 14 18

2. Shabby

37 27 4 24 31

5. Level-headed

20 26 7 34 2 33 13 9

3. Flourish

15 22 8 29 10 38

6. "Walden" author

30 19 6 25 11 23 36

1	2	3	4	5	6	7		8	9	10	11	12	13	14
	15	16	17	18	19	20		21	22	23	24		25	26
27	28	29	30	31		32	33	34	35	36	37	38	39	

1. Tom -----  
(cocktail)

13 33 39 23 43 6 16

4. Duckbill

36 14 29 8 38 4 2 20

2. Propelled a canoe

37 35 42 30 27 22 24

7. Wonderful!

31 3 40 21 34 17 12 45

3. Intersection

1 15 41 10 32 5 25 44

8. Cobra killer

26 9 19 7 11 18 46 28

1	2	3	4	5	6	7		8	9		10	11	12	13	14	15	16
17	18	19	20		21	22	23	24	25	26		27	28	29	30	31	
32	33		34	35	36	37	38		39	40	41	42	43	44	45	46	

1. Inquisitive

16 42 8 28

6. Breath freshener

3 50 30 36 18 25 55 40 62

2. Nimble

38 12 15 5 65

7. Afro (e.g.)

37 33 21 56 2 45 49 10 19

3. Way to go

31 26 51 57 35

8. Cloyed

44 9 39 11 47 61 54 23

4. Anger

43 52 60 17 13

9. Filmy fabric

34 46 4 27 32 63 22

5. Pacific island

14 1 41 58 48 7

10. By any means

59 24 64 6 53 29 20

1		2	3	4	5	6		7	8		9		10	11	12	13	14		15	16
	17	18	19		20	21	22	23	24	25		26	27		28	29	30	31		32
33	34	35		36	37	38	39		40	41	42	43	44		45	46	47	48		49
50	51	52		53	54	55	56	57		58	59		60	61		62	63	64	65	



# Vacation Fun

## The Story

On a recent trip to Transylvania, Bertram, Vincent, Borka, Peter and Fred became vampires. Their last names were Luther, Pratt, Kane, Locke and Knight, but not necessarily in that order. One of them was bitten by a wandering vampire and he in turn bit one of his companions, who in turn bit another companion, who in turn bit another, who in turn bit another until all were infected. They discovered good things and bad things about being vampires. The good things were flying, sleeping all day, living forever, biting people in the neck and nice teeth. The bad things were boring food, no suntan, your friends were all pains in the neck, coffin repair and changing into a bat all the time. Based on the clues, match the vampires with their last names, the correct order of infection and each vampire's likes and dislikes.

## The Clues

1. Kane, Bertram, Knight and Fred were not bitten 1<sup>st</sup> on the vampire bit parade.
2. Vincent had not infected anyone yet, but Peter was the one who infected Bertram.
3. Bertram was not named Luther or Locke and he was infected after Borka and Fred were infected.
4. Borka was not Locke, and Vincent was not Knight.
5. The last two vampires to be infected liked either sleeping all day or living forever and disliked either the lack of a suntan or the pain in the neck friends.
6. The vampire who enjoyed biting people and disliked changing into a bat was not infected 1<sup>st</sup> or 2<sup>nd</sup>.
7. Kane did not like sleeping all day, the vampire bitten 1<sup>st</sup> loved the flying and Fred enjoyed repairing his coffin.
8. One vampire, who was not infected last, really disliked not having a suntan more than anything else

Bertram	Vincent	Borka	Peter	Fred
Luther	Luther	Luther	Luther	Luther
Pratt	Pratt	Pratt	Pratt	Pratt
Kane	Kane	Kane	Kane	Kane
Locke	Locke	Locke	Locke	Locke
Knight	Knight	Knight	Knight	Knight
1 <sup>st</sup>	1 <sup>st</sup>	1 <sup>st</sup>	1 <sup>st</sup>	1 <sup>st</sup>
2 <sup>nd</sup>	2 <sup>nd</sup>	2 <sup>nd</sup>	2 <sup>nd</sup>	2 <sup>nd</sup>
3 <sup>rd</sup>	3 <sup>rd</sup>	3 <sup>rd</sup>	3 <sup>rd</sup>	3 <sup>rd</sup>
4 <sup>th</sup>	4 <sup>th</sup>	4 <sup>th</sup>	4 <sup>th</sup>	4 <sup>th</sup>
5 <sup>th</sup>	5 <sup>th</sup>	5 <sup>th</sup>	5 <sup>th</sup>	5 <sup>th</sup>
Flying	Flying	Flying	Flying	Flying
Sleeping all day	Sleeping all day	Sleeping all day	Sleeping all day	Sleeping all day
Living forever	Living forever	Living forever	Living forever	Living forever
Biting people	Biting people	Biting people	Biting people	Biting people
Nice teeth	Nice teeth	Nice teeth	Nice teeth	Nice teeth
Boring food	Boring food	Boring food	Boring food	Boring food
No suntan	No suntan	No suntan	No suntan	No suntan
Friends a pain	Friends a pain	Friends a pain	Friends a pain	Friends a pain
Coffin repair	Coffin repair	Coffin repair	Coffin repair	Coffin repair
Changing to bat	Changing to bat	Changing to bat	Changing to bat	Changing to bat

# Chasing Tourists

## The Story

Five environmentally committed married couples decided to go on a safari together to view the wild creatures in their natural habitat. One exciting day they decided to split up into five groups to go view the animals, and they also decided that no husbands and wives would go out together that day. All ten people, in groups of two, were chased by warthogs, baboons, hyenas, lions, and jackals. The married couples were Bart and Sybil, Ricky and Leah, Arthur and Edith, Ralph and Alicia and Oscar and Harriet. Their guides were Bo, Leo, Manley, Sam and Curtis. The guides all yelled something to the people as the animals started to chase them. They yelled “yikes,” “jeepers,” “don’t worry,” “chill out,” and “run faster.” Based on the clues, match the animals with the names of the people they chased, their guides and what the guides yelled.

## The Clues

1. No husbands were chased with their wives, and the hyenas, lions and jackals did not chase Bart, Ricky, Sybil or Leah.
2. Sybil’s guide was Manley who yelled “yikes” when the baboons chased them.
3. Arthur was chased with Harriet, Ralph was chased with Edith, while Oscar was chased by lions.
4. Arthur’s guide Leo was a bit optimistic when he yelled “don’t worry.”
5. Ralph’s guide yelled “run faster,” and it was not either Sam or Curtis.
6. Edith was not chased by jackals, Leah’s guide was not Curtis, and Alicia’s guide did not yell “jeepers.”

Warthogs	Baboons	Hyenas	Lions	Jackals
Bart	Bart	Bart	Bart	Bart
Ricky	Ricky	Ricky	Ricky	Ricky
Arthur	Arthur	Arthur	Arthur	Arthur
Ralph	Ralph	Ralph	Ralph	Ralph
Oscar	Oscar	Oscar	Oscar	Oscar
Sybil	Sybil	Sybil	Sybil	Sybil
Leah	Leah	Leah	Leah	Leah
Edith	Edith	Edith	Edith	Edith
Alicia	Alicia	Alicia	Alicia	Alicia
Harriet	Harriet	Harriet	Harriet	Harriet
Bo	Bo	Bo	Bo	Bo
Leo	Leo	Leo	Leo	Leo
Manley	Manley	Manley	Manley	Manley
Sam	Sam	Sam	Sam	Sam
Curtis	Curtis	Curtis	Curtis	Curtis
“yikes”	“yikes”	“yikes”	“yikes”	“yikes”
“jeepers”	“jeepers”	“jeepers”	“jeepers”	“jeepers”
“don’t worry”	“don’t worry”	“don’t worry”	“don’t worry”	“don’t worry”
“chill out”	“chill out”	“chill out”	“chill out”	“chill out”
“run faster”	“run faster”	“run faster”	“run faster”	“run faster”

### Petal Pairs:

For each of the flowers, can you find two letters which, when placed in the center, will form three six-letter words? Each word starts in a darker petal and ends in the lighter petal which is directly opposite.

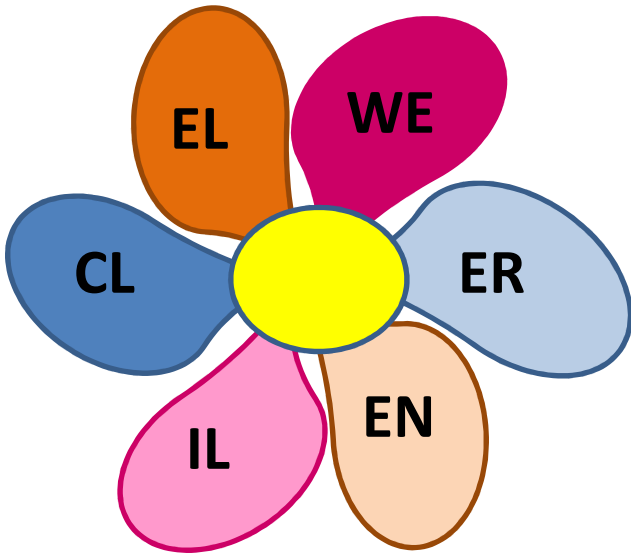

- |    |    |
|----|----|
| 1. | 4. |
| 2. | 5. |
| 3. | 6. |

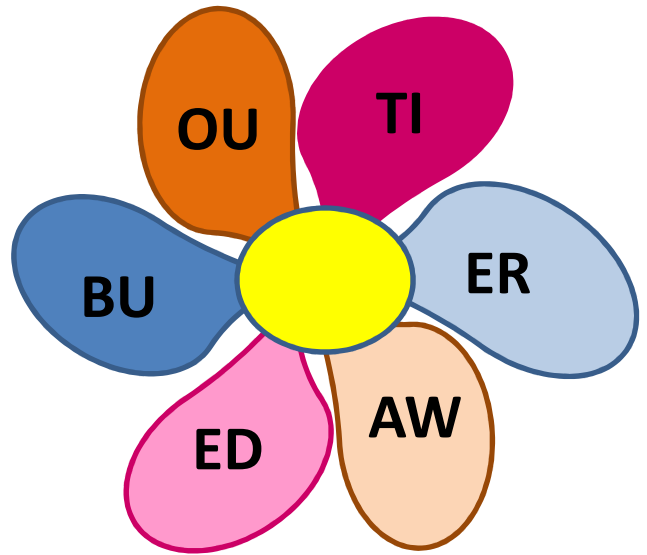

- |    |    |
|----|----|
| 1. | 4. |
| 2. | 5. |
| 3. | 6. |

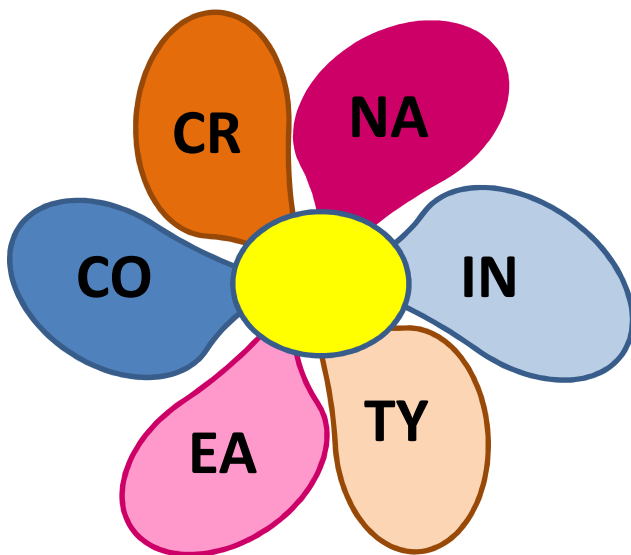

- |    |    |
|----|----|
| 1. | 4. |
| 2. | 5. |
| 3. | 6. |

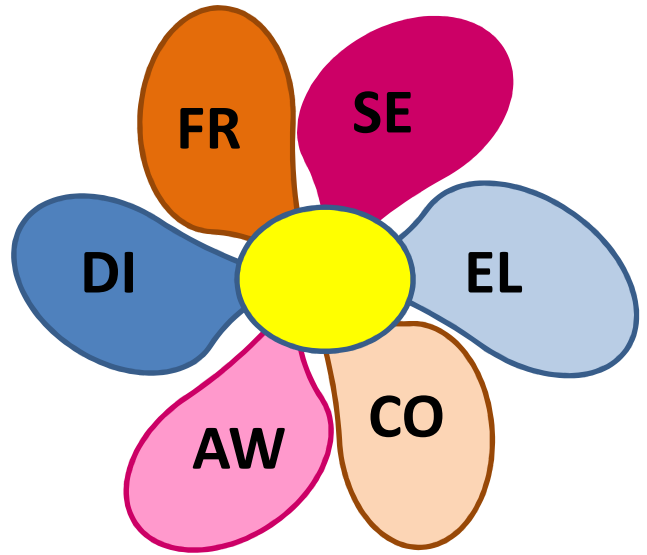

- |    |    |
|----|----|
| 1. | 4. |
| 2. | 5. |
| 3. | 6. |

### Petal Pairs:

For each of the flowers, can you find two letters which, when placed in the center, will form three six-letter words? Each word starts in a darker petal and ends in the lighter petal which is directly opposite.

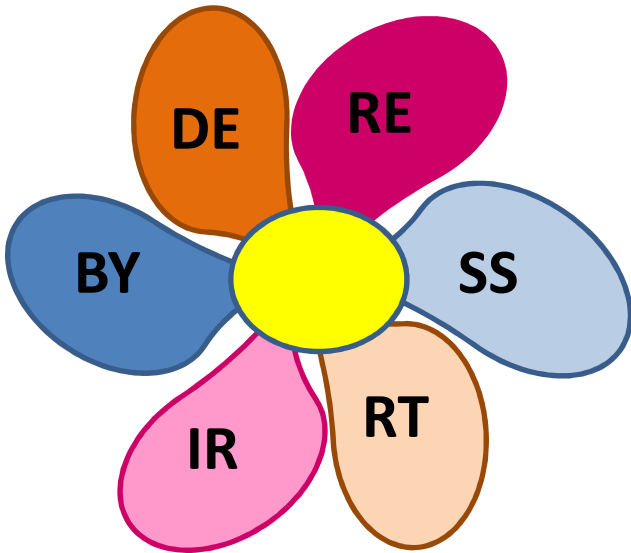

- |    |    |
|----|----|
| 1. | 4. |
| 2. | 5. |
| 3. | 6. |

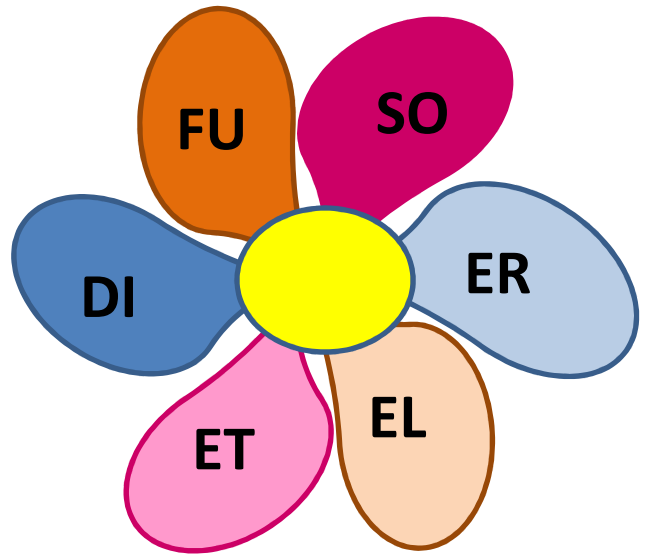

- |    |    |
|----|----|
| 1. | 4. |
| 2. | 5. |
| 3. | 6. |

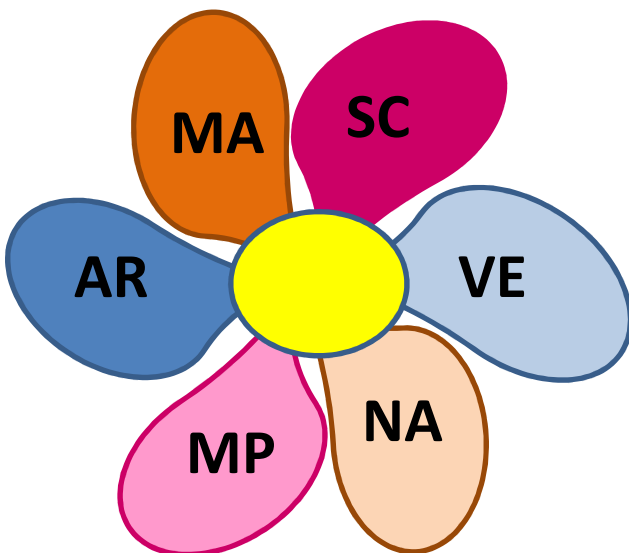

- |    |    |
|----|----|
| 1. | 4. |
| 2. | 5. |
| 3. | 6. |

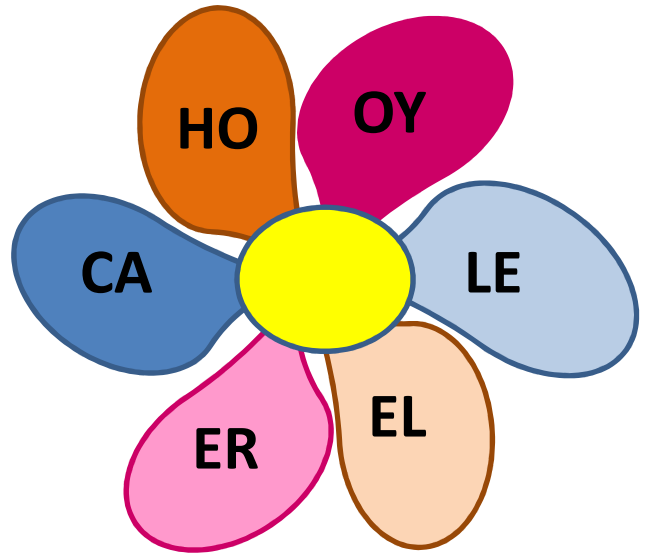

- |    |    |
|----|----|
| 1. | 4. |
| 2. | 5. |
| 3. | 6. |

### Word Wheel:

How many words of three or more letters can you make from those in the wheel, without using plurals, abbreviations or proper nouns? The central letter must appear once in every word and no letter in the wheel may be used more than once. You must also identify the one nine-letter word in the wheel.

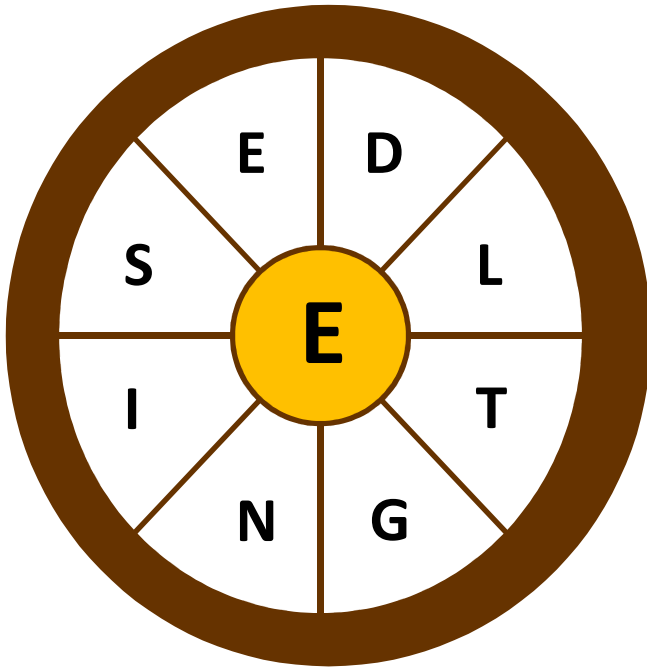

### Identified Words:

The nine-letter word is:

---

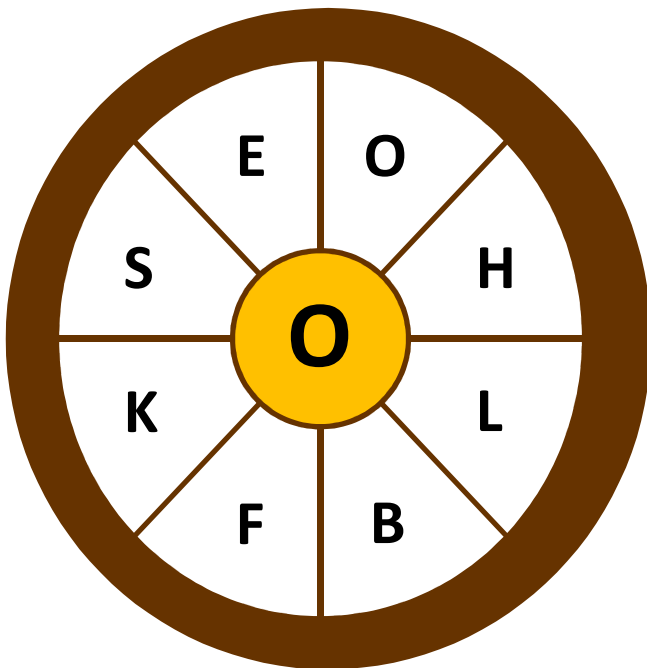

### Identified Words:

The nine-letter word is:

---



### Word Wheel:

How many words of three or more letters can you make from those in the wheel, without using plurals, abbreviations or proper nouns? The central letter must appear once in every word and no letter in the wheel may be used more than once. You must also identify the one nine-letter word in the wheel.

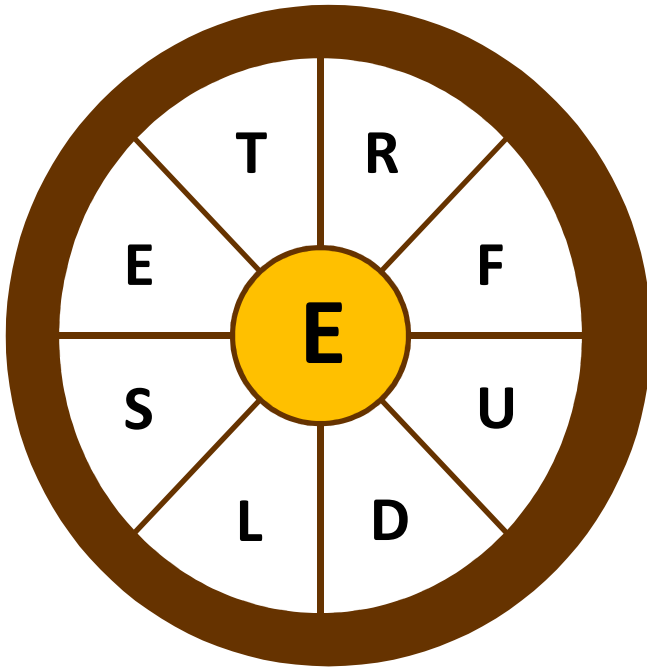

### Identified Words:

The nine-letter word is:

---

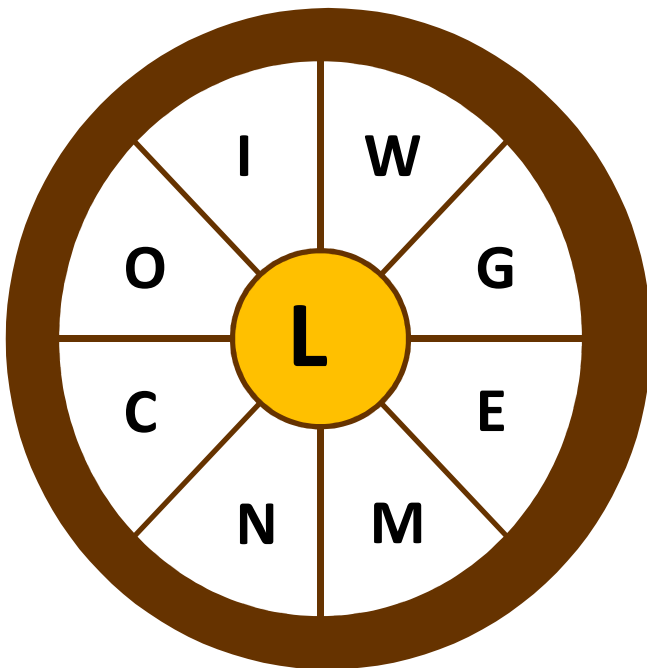

### Identified Words:

The nine-letter word is:

---

# WORD WINKS

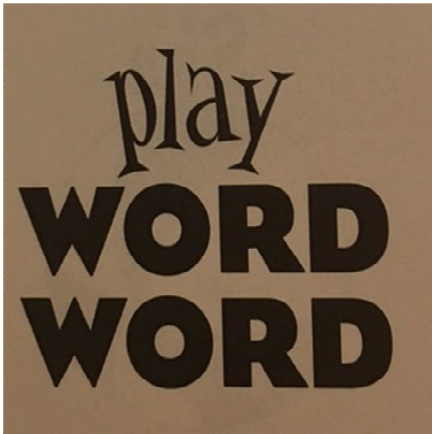

Phrase: \_\_\_\_\_  
\_\_\_\_\_

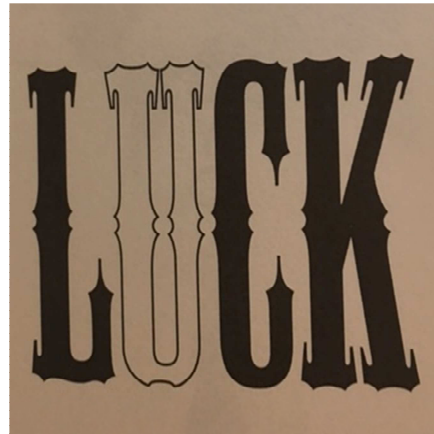

Phrase: \_\_\_\_\_  
\_\_\_\_\_



Phrase: \_\_\_\_\_  
\_\_\_\_\_

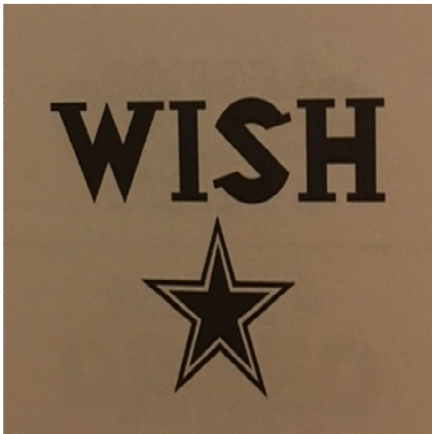

Phrase: \_\_\_\_\_  
\_\_\_\_\_

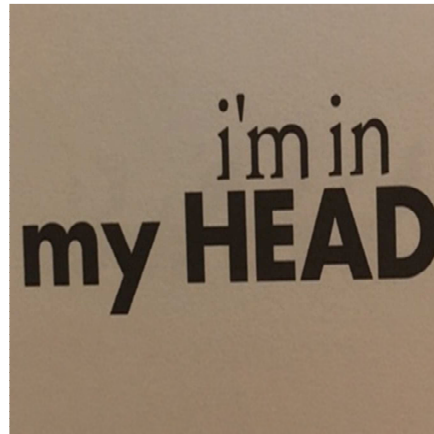

Phrase: \_\_\_\_\_  
\_\_\_\_\_



Phrase: \_\_\_\_\_  
\_\_\_\_\_

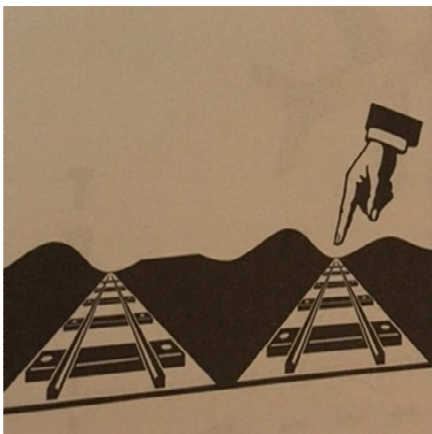

Phrase: \_\_\_\_\_  
\_\_\_\_\_

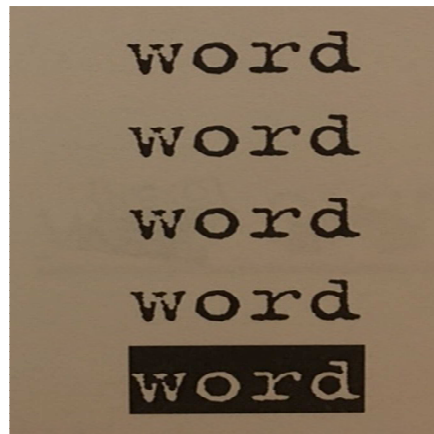

Phrase: \_\_\_\_\_  
\_\_\_\_\_

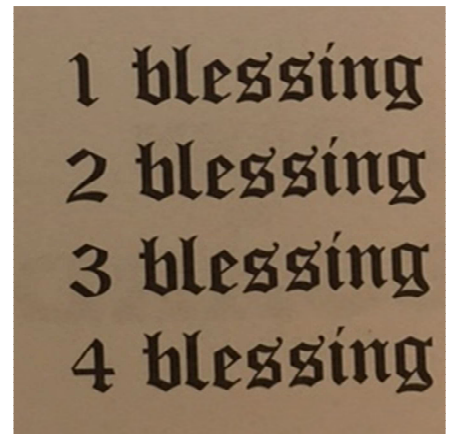

Phrase: \_\_\_\_\_  
\_\_\_\_\_

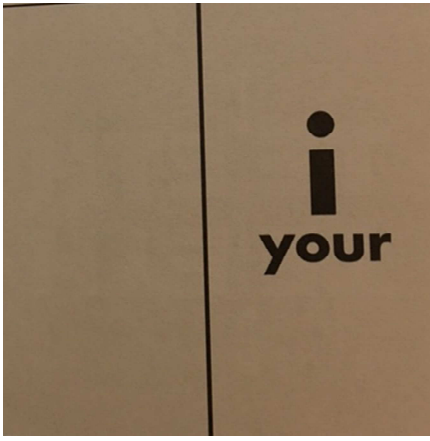

Phrase: \_\_\_\_\_  
\_\_\_\_\_

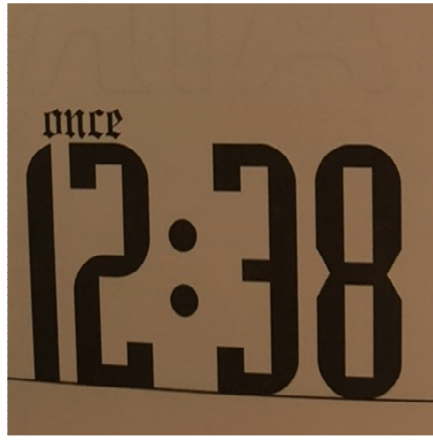

Phrase: \_\_\_\_\_  
\_\_\_\_\_

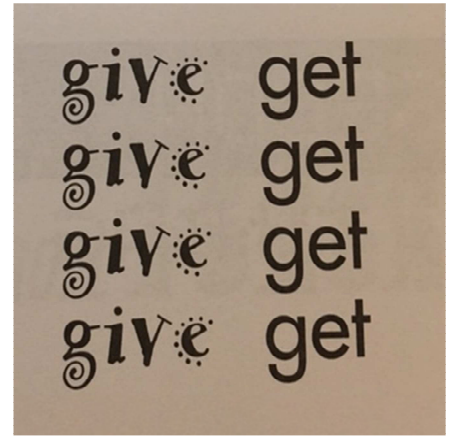

Phrase: \_\_\_\_\_  
\_\_\_\_\_

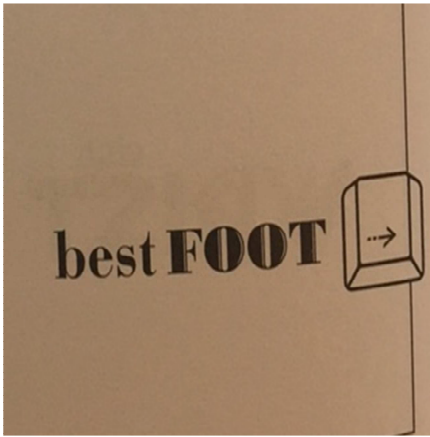

Phrase: \_\_\_\_\_  
\_\_\_\_\_

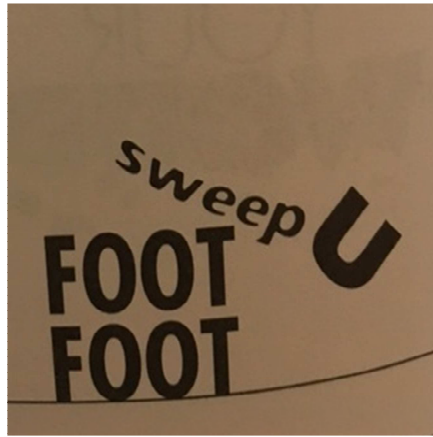

Phrase: \_\_\_\_\_  
\_\_\_\_\_

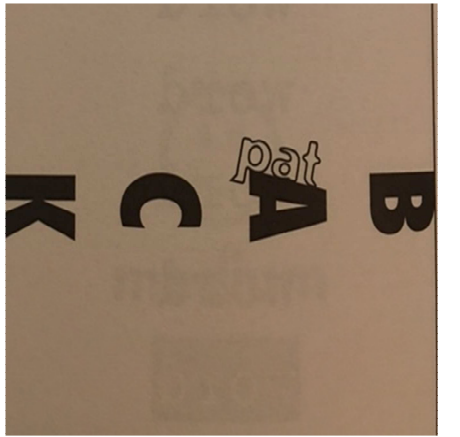

Phrase: \_\_\_\_\_  
\_\_\_\_\_



Phrase: \_\_\_\_\_  
\_\_\_\_\_

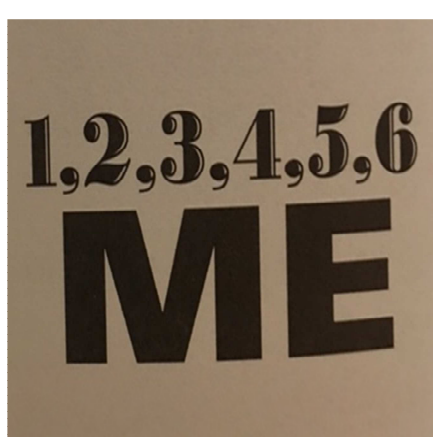

Phrase: \_\_\_\_\_  
\_\_\_\_\_

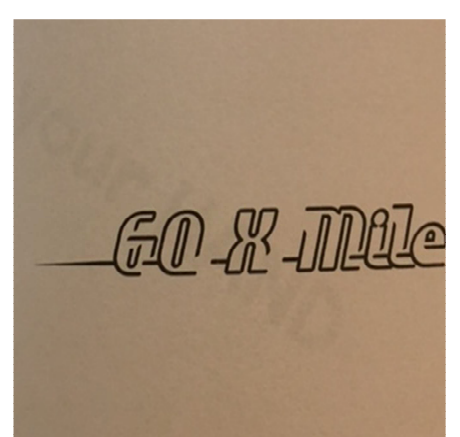

Phrase: \_\_\_\_\_  
\_\_\_\_\_

## Chain Reaction:

Solve this puzzle by creating a 'chain reaction' of 20 five-letter words. These run left to right, beginning in the upper-left hand corner and use the 19 two-letter tiles in the center. A two-letter tile that ends one begins the next. Each tile will only be used once. The single letters already entered are the center letters of the words you are to form. Start by finishing the world that begins BLA\_ \_.

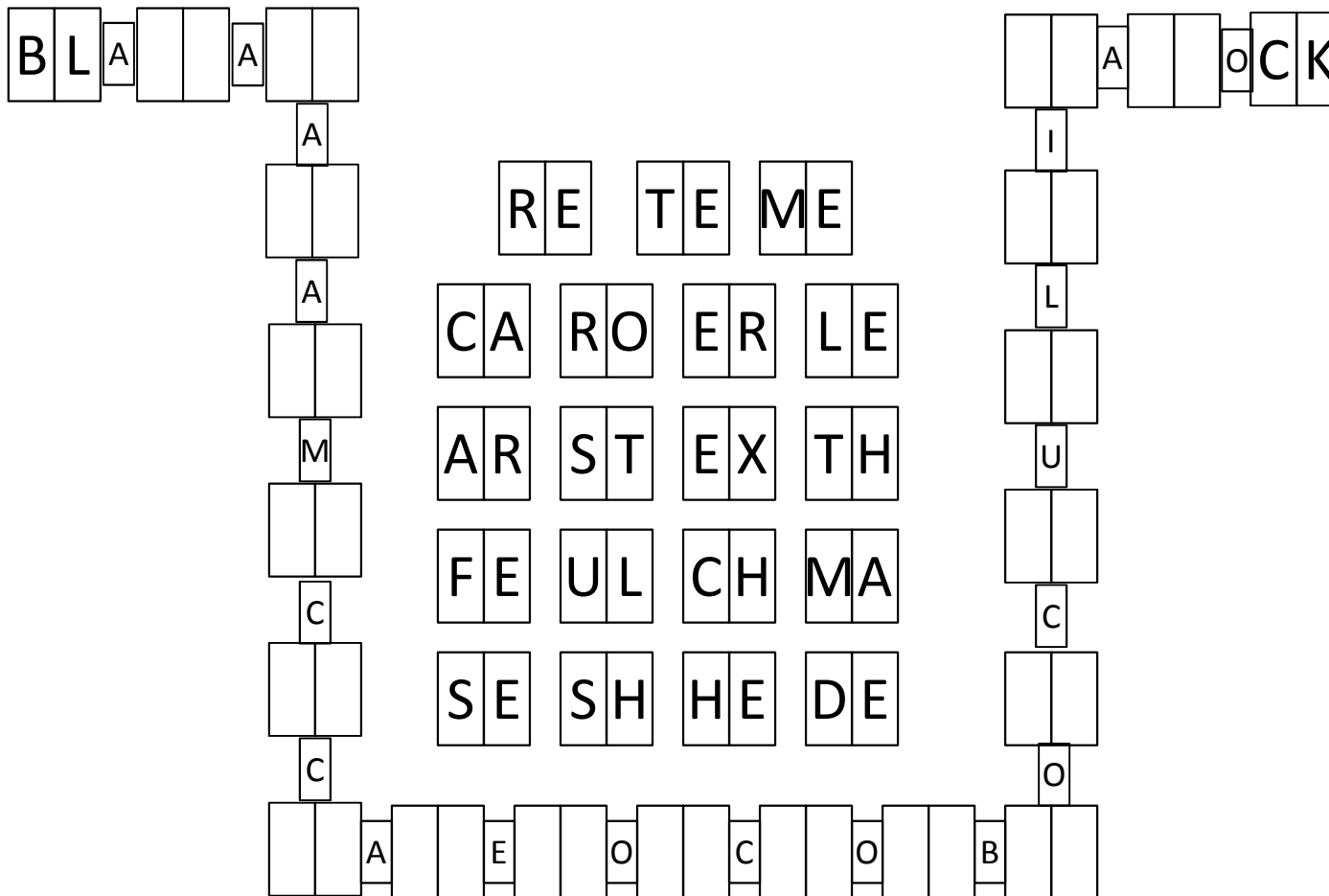

## Chain Reaction:

Solve this puzzle by creating a 'chain reaction' of 20 five-letter words. These run left to right, beginning in the upper-left hand corner and use the 19 two-letter tiles in the center. A two-letter tile that ends one begins the next. Each tile will only be used once. The single letters already entered are the center letters of the words you are to form. Start by finishing the world that begins BLA\_ \_.

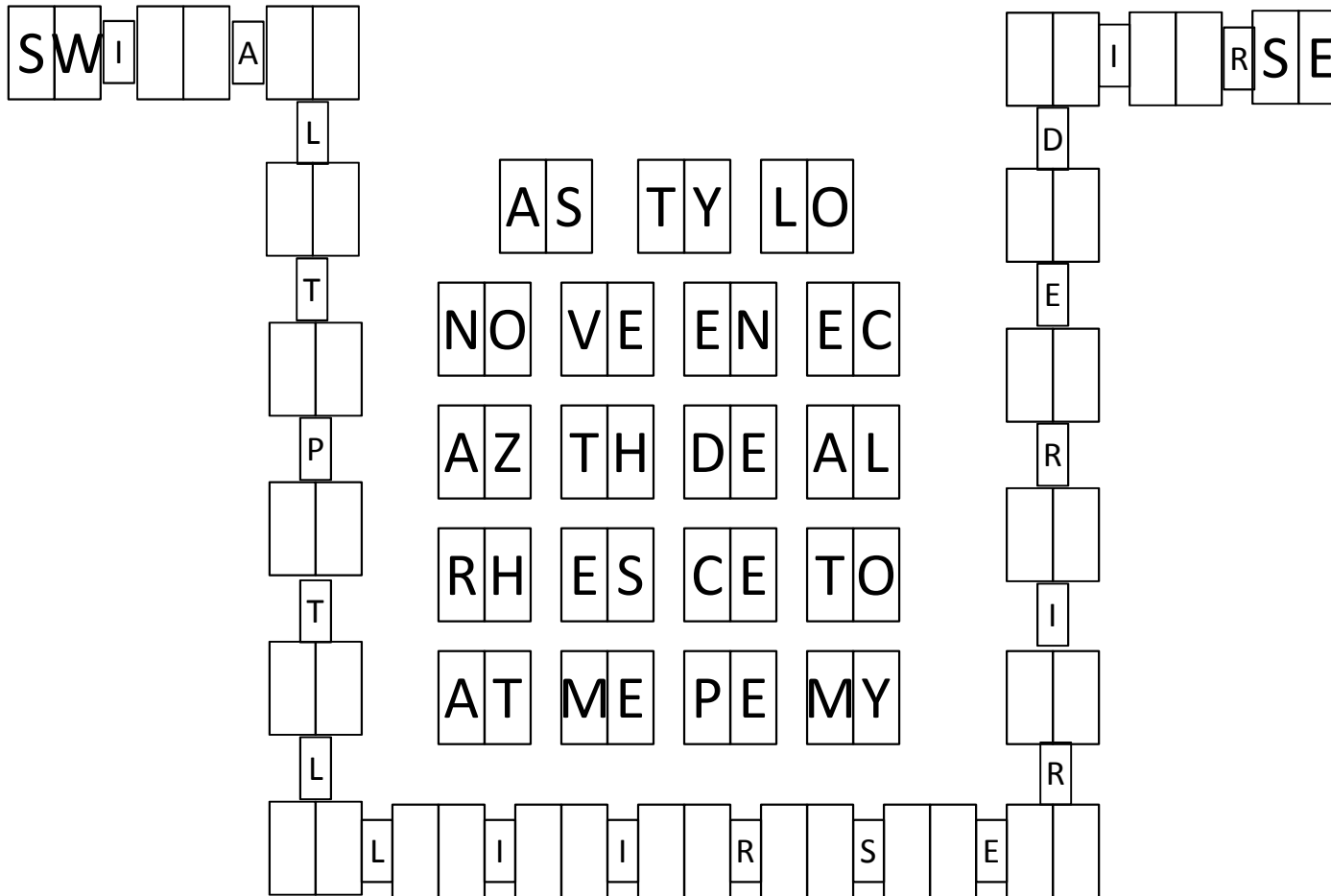

# Honeycomb Loops

Draw a continuous loop which passes through no hexagon more than once. A value within a cell indicates the number of adjacent hexagons through which the loop passes. The loop cannot pass through a numbered cell, nor make a "V" turn. A "V" turn consists of passing from one cell into another, and then back into a cell adjacent to the first.

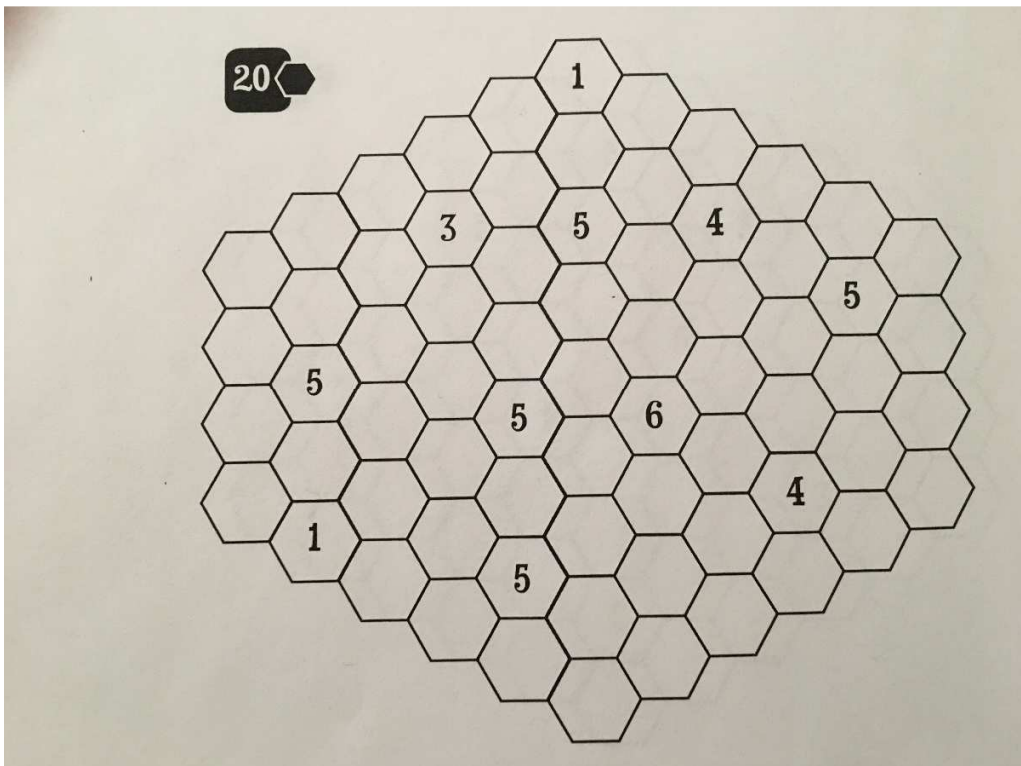
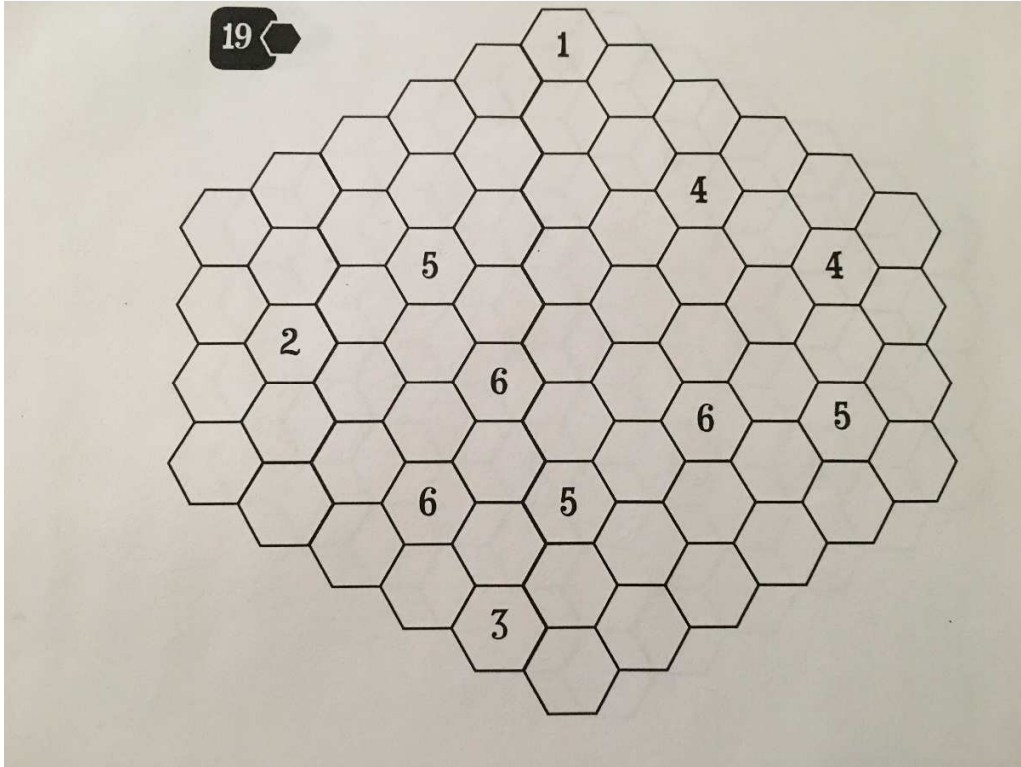

25

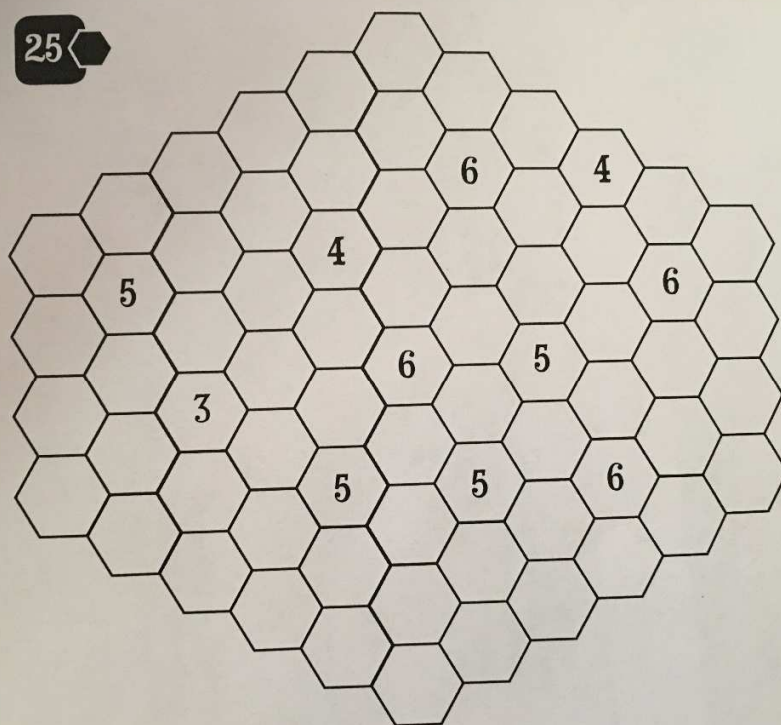

26

